

Article number: 2314450685

Description: E+G polyamide wheel

RE.F8-100-FBL-N - Turning plate wo/brake in Zinc-plated steel

Measures

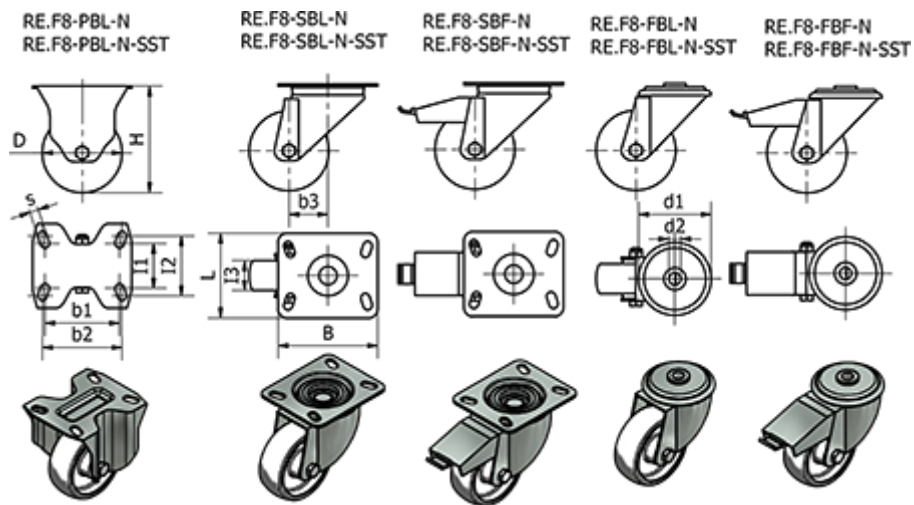

= -	d2	= 12	Rolling resistance (N) = 1750
B =	Dynamic carrying capacity (N) = 2000		s =
b1 =	H	= 128	Type = RE.F8-100-FBL-N
b2 =	l1	=	Wight (g) = 555
b3 = 35	l2	=	
Code = 450685	l3	= 30	
D = 100	L	=	
d1 = 73	R	= -	